

Input-Output Models

Real-Time Systems, Lecture 7

Martina Maggio

6 February 2020

Lund University, Department of Automatic Control

Lecture 7: Input-Output Models

[IFAC PB Ch 3 p 22-34]

- Shift operators; the pulse transfer operator
- Z-transform; the pulse transfer function
- Transformations between system representations
- System response, frequency response
- ZOH sampling of a transfer function

Linear System Models

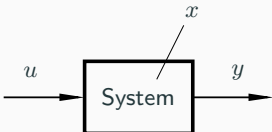
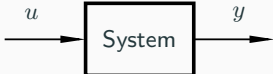
	State-space model	Input-output models	
			
		Differential/difference equation	Transfer operator/fcn
CT	$\dot{x}(t) = Ax(t) + Bu(t)$ $y(t) = Cx(t)$	$\frac{d^n y}{dt^n} + a_1 \frac{d^{n-1} y}{dt^{n-1}} + \dots + a_n y$ $= b_1 \frac{d^{n-1} u}{dt^{n-1}} + \dots + b_n u$	$G(p) / G(s)$
DT	$x(k+1) = \Phi x(k) + \Gamma u(k)$ $y(k) = Cx(k)$	$y(k) + a_1 y(k-1) + \dots +$ $a_n y(k-n) = b_1 u(k-1)$ $+ \dots + b_n u(k-n)$	$H(q) / H(z)$

More I-O models: (im)pulse response, step response, frequency response

Shift Operators

Operators on time series

The sampling period is chosen as the time unit ($f(k) \Leftrightarrow f(kh)$)

Time series are doubly infinite sequences:

- $f(k) : k = \dots - 1, 0, 1, \dots$

Forward shift operator:

- denoted q
- $qf(k) = f(k + 1)$
- $q^n f(k) = f(k + n)$

Backward shift operator:

- denoted q^{-1}
- $q^{-1}f(k) = f(k - 1)$
- $q^{-n}f(k) = f(k - n)$

Pulse Transfer Operator

Rewrite the state-space model using the forward shift operator:

$$\begin{aligned}x(k+1) &= qx(k) = \Phi x(k) + \Gamma u(k) \\y(k) &= Cx(k) + Du(k)\end{aligned}$$

Eliminate $x(k)$:

$$\begin{aligned}x(k) &= (qI - \Phi)^{-1} \Gamma u(k) \\y(k) &= Cx(k) + Du(k) = C(qI - \Phi)^{-1} \Gamma u(k) + Du(k) \\&= [C(qI - \Phi)^{-1} \Gamma + D] u(k) = H(q)u(k)\end{aligned}$$

$H(q)$ is the *pulse transfer operator* of the system

Describes how the input and output are related.

Poles and Zeros (SISO case)

The pulse transfer function is a rational function

$$H(q) = \frac{B(q)}{A(q)}$$

$\deg A = n =$ the number of states

$\deg B = n_b \leq n$ (otherwise the system would be acausal)

$A(q)$ is the characteristic polynomial of Φ , i.e.

$$A(q) = \det(qI - \Phi)$$

The *poles* of the system are given by $A(q) = 0$

The *zeros* of the system are given by $B(q) = 0$

Interpretation of Poles and Zeros

Poles:

- A pole in a is associated with the time function $f(k) = a^k$

Zeros:

- A zero in a implies that the transmission of the input $u(k) = a^k$ is blocked by the system
- Related to how inputs and outputs are coupled to the states

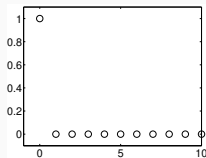
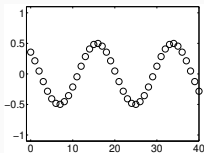

Disk Drive Example

Recall the double integrator from the previous lecture:

$$\frac{dx}{dt} = \begin{bmatrix} 0 & 1 \\ 0 & 0 \end{bmatrix} x + \begin{bmatrix} 0 \\ 1 \end{bmatrix} u$$
$$y = [1 \quad 0] x$$

Sample with $h = 1$:

$$\Phi = e^{Ah} = \begin{bmatrix} 1 & 1 \\ 0 & 1 \end{bmatrix}$$
$$\Gamma = \int_0^h e^{As} B ds = \begin{bmatrix} 0.5 \\ 1 \end{bmatrix}$$

Disk Drive Example

Pulse transfer operator:

$$\begin{aligned} H(q) &= C(qI - \Phi)^{-1}\Gamma + D \\ &= [1 \quad 0] \begin{bmatrix} q-1 & -1 \\ 0 & q-1 \end{bmatrix}^{-1} \begin{bmatrix} 0.5 \\ 1 \end{bmatrix} = \frac{0.5(q+1)}{(q-1)^2} \end{aligned}$$

Two poles in 1, one zero in -1 .

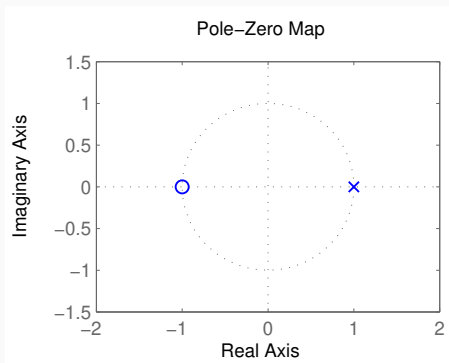

From Pulse Transfer Operator to Difference Equation

$$y(k) = H(q)u(k)$$

$$A(q)y(k) = B(q)u(k)$$

$$(q^n + a_1q^{n-1} + \cdots + a_n)y(k) = (b_0q^{n_b} + \cdots + b_{n_b})u(k)$$

which means

$$\begin{aligned}y(k+n) + a_1y(k+n-1) + \cdots + a_ny(k) \\ = b_0u(k+n_b) + \cdots + b_{n_b}u(k)\end{aligned}$$

Difference Equation with Backward Shift

$$\begin{aligned}y(k+n) + a_1y(k+n-1) + \cdots + a_ny(k) \\ = b_0u(k+n_b) + \cdots + b_{n_b}u(k)\end{aligned}$$

can be written as

$$\begin{aligned}y(k) + a_1y(k-1) + \cdots + a_ny(k-n) \\ = b_0u(k-d) + \cdots + b_{n_b}u(k-d-n_b)\end{aligned}$$

where $d = n - n_b$ is the *pole excess* of the system.

Difference Equation with Backward Shift

The *reciprocal polynomial*

$$A^*(q) = 1 + a_1q + \cdots + a_nq^n = q^n A(q^{-1})$$

is obtained from the polynomial A by reversing the order of the coefficients.

Now the system can instead be written as

$$A^*(q^{-1})y(k) = B^*(q^{-1})u(k - d)$$

Difference Equation Example

Using forward shift

$$y(k+2) + 2y(k+1) + 3y(k) = 2u(k+1) + u(k)$$

can be written

$$(q^2 + 2q + 3)y(k) = (2q + 1)u(k)$$

Hence,

$$A(q) = q^2 + 2q + 3$$

$$B(q) = 2q + 1$$

Using backward shift, the same equation can be written ($d = 1$)

$$(1 + 2q^{-1} + 3q^{-2})y(k) = (2 + q^{-1})u(k-1)$$

Hence,

$$A^*(q^{-1}) = 1 + 2q^{-1} + 3q^{-2}$$

$$B^*(q^{-1}) = 2 + q^{-1}$$

The discrete-time counterpart to the Laplace transform

Defined on semi-infinite time series $f(k) : k = 0, 1, \dots$

$$\mathcal{Z}\{f(k)\} = F(z) = \sum_{k=0}^{\infty} f(k)z^{-k}$$

z is a complex variable

Example – Discrete-Time Step Signal

Let $y(k) = 1$ for $k \geq 0$. Then

$$Y(z) = 1 + z^{-1} + z^{-2} + \dots = \frac{z}{z-1}, \quad |z| > 1$$

Application of the following result for power series

$$\sum_{k=0}^{\infty} x^k = \frac{1}{1-x} \text{ for } |x| < 1$$

Z-transform Table

Table 2 (p 26) in IFAC PB (ignore the middle column!)

f	$\mathcal{L}f$	$\mathcal{Z}f$
$\delta(k)$ (pulse)	–	1
1 $k \geq 0$ (step)	$\frac{1}{s}$	$\frac{z}{z-1}$
kh	$\frac{1}{s^2}$	$\frac{hz}{(z-1)^2}$
$\frac{1}{2}(kh)^2$	$\frac{1}{s^3}$	$\frac{h^2 z(z+1)}{2(z-1)^3}$
$e^{-kh/T}$	$\frac{T}{1+sT}$	$\frac{z}{z-e^{-h/T}}$
$1 - e^{-kh/T}$	$\frac{1}{s(1+sT)}$	$\frac{z(1-e^{-h/T})}{(z-1)(z-e^{-h/T})}$
$\sin \omega kh$	$\frac{\omega}{s^2 + \omega^2}$	$\frac{z \sin \omega h}{z^2 - 2z \cos \omega h + 1}$

Some Properties of the Z-transform

$$\mathcal{Z}(\alpha f + \beta g) = \alpha F(z) + \beta G(z)$$

$$\mathcal{Z}(q^{-n} f) = z^{-n} F(z)$$

$$\mathcal{Z}(qf) = z(F(z) - f(0))$$

$$\mathcal{Z}(f * g) = \mathcal{Z} \left\{ \sum_{j=0}^k f(j)g(k-j) \right\} = F(z)G(z)$$

From State Space to Pulse Transfer Function

$$\begin{cases} x(k+1) = \Phi x(k) + \Gamma u(k) \\ y(k) = Cx(k) + Du(k) \end{cases}$$

$$\begin{cases} z(X(z) - x(0)) = \Phi X(z) + \Gamma U(z) \\ Y(z) = CX(z) + DU(z) \end{cases}$$

$$Y(z) = C(zI - \Phi)^{-1} z x(0) + [C(zI - \Phi)^{-1} \Gamma + D]U(z)$$

The rational function $H(z) = C(zI - \Phi)^{-1} \Gamma + D$ is called the *pulse transfer function* from u to y .

It is the Z-transform of the pulse response $h(k)$

$H(q)$ vs $H(z)$

The pulse transfer operator $H(q)$ and the pulse transfer function $H(z)$ are the same rational functions

They have the same poles and zeros

- $H(q)$ is used in the time domain ($q =$ shift operator)
- $H(z)$ is used in the Z-domain ($z =$ complex variable)

If the order of $H(q)$ or $H(z)$ is less than the order of the original state-space system, i.e., a pole-zero cancellation has taken place, then the system is either not reachable or not observable

Calculating System Response Using the Z-transform

1. Find the pulse transfer function $H(z) = C(zI - \Phi)^{-1}\Gamma + D$
2. Compute the Z-transform of the input: $U(z) = \mathcal{Z}\{u(k)\}$
3. Compute the Z-transform of the output:

$$Y(z) = C(zI - \Phi)^{-1}z x(0) + H(z)U(z)$$

4. Apply the inverse Z-transform (table) to find the output:
 $y(k) = \mathcal{Z}^{-1}\{Y(z)\}$

Frequency Response – Continuous Time

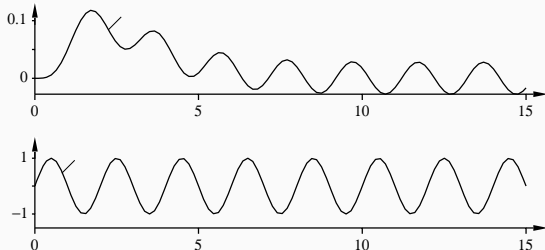

Given a stable system $G(s)$, the input $u(t) = \sin \omega t$ will, after a transient, give the output

$$y(t) = |G(i\omega)| \sin(\omega t + \arg G(i\omega))$$

- The amplitude and phase shift for different frequencies are given by the value of $G(s)$ along the imaginary axes, i.e. $G(i\omega)$
- Plotted in Bode and Nyquist diagrams

Frequency Response – Discrete Time

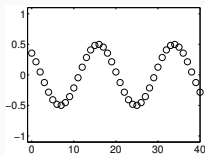
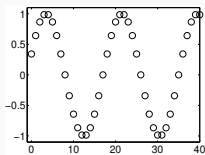

Given a stable system $H(z)$, the input $u(k) = \sin(\omega k)$ will, after a transient, give the output

$$y(k) = |H(e^{i\omega})| \sin(\omega k + \arg H(e^{i\omega}))$$

- $G(s)$ and the imaginary axis are replaced by $H(z)$ and the unit circle.
- Only describes what happens at the sampling instants
- The inter-sample behavior is not studied in this course

Bode Diagram

Bode diagram for $G(s) = 1/(s^2 + 1.4s + 1)$ (solid) and ZOH-sampled counterpart $H(z)$ (dashed, plotted for $\omega h \in [0, \pi]$)

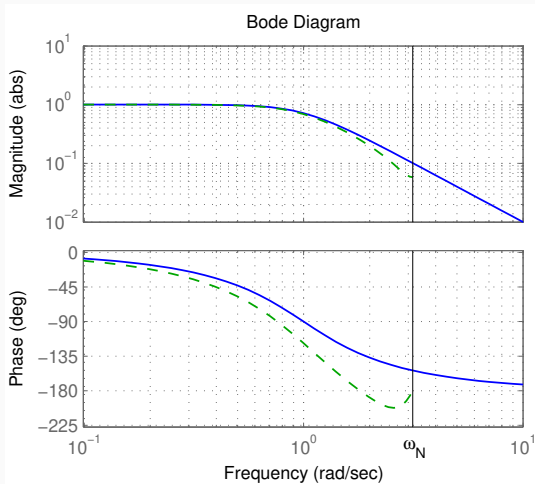

The hold circuit can be approximated by a delay of $h/2$

Nyquist Diagram

Nyquist diagram for $G(s) = 1/(s^2 + 1.4s + 1)$ (solid) and ZOH-sampled counterpart $H(z)$ (dashed, plotted for $\omega h \in [0, \pi]$)

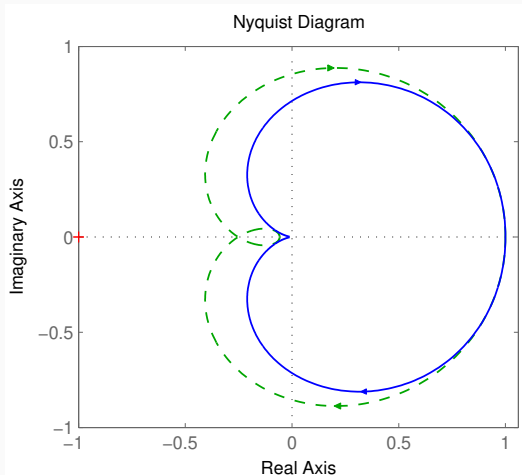

ZOH Sampling of a Transfer Function

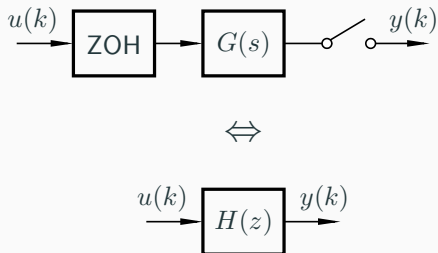

How to calculate $H(z)$ given $G(s)$?

Calculation of $H(z)$ Given $G(s)$

Three approaches:

1. Make a state-space realization of $G(s)$. Sample using ZOH to obtain Φ and Γ . Then $H(z) = C(zI - \Phi)^{-1}\Gamma + D$.

- Works also for systems with time delays, $G(s)e^{-s\tau}$

2. Use the formula

$$\begin{aligned} H(z) &= \frac{z-1}{z} \frac{1}{2\pi i} \int_{\gamma-i\infty}^{\gamma+i\infty} \frac{e^{sh}}{z - e^{sh}} \frac{G(s)}{s} ds \\ &= \sum_{s=s_i} \frac{1}{z - e^{sh}} \operatorname{Res} \left\{ \frac{e^{sh} - 1}{s} G(s) \right\} \end{aligned}$$

- s_i are the poles of $G(s)$ and Res denotes the residue.
- outside the scope of the course

Calculation of $H(z)$ Given $G(s)$

3. Use Table 3 (p 27) in IFAC PB

$G(s)$	$H(z) = \frac{b_1 z^{n-1} + b_2 z^{n-2} + \dots + b_n}{z^n + a_1 z^{n-1} + \dots + a_n}$	
$\frac{1}{s}$	$\frac{h}{z-1}$	
$\frac{1}{s^2}$	$\frac{h^2(z+1)}{2(z-1)^2}$	
e^{-sh}	z^{-1}	
$\frac{a}{s+a}$	$\frac{1 - \exp(-ah)}{z - \exp(-ah)}$	
$\frac{a}{s(s+a)}$	$b_1 = \frac{1}{a}(ah - 1 + e^{-ah})$ $a_1 = -(1 + e^{-ah})$	$b_2 = \frac{1}{a}(1 - e^{-ah} - ahe^{-ah})$ $a_2 = e^{-ah}$

Calculation of $H(z)$ Given $G(s)$

Example: For $G(s) = e^{-\tau s}/s^2$, the previous lecture gave

$$x(kh + h) = \Phi x(kh) + \Gamma_1 u(kh - h) + \Gamma_0 u(kh)$$

$$\Phi = \begin{pmatrix} 1 & h \\ 0 & 1 \end{pmatrix} \quad \Gamma_1 = \begin{pmatrix} \tau \left(h - \frac{\tau}{2} \right) \\ \tau \end{pmatrix} \quad \Gamma_0 = \begin{pmatrix} \frac{(h - \tau)^2}{2} \\ h - \tau \end{pmatrix}$$

With $h = 1$ and $\tau = 0.5$, this gives

$$H(z) = C(zI - \Phi)^{-1}(\Gamma_0 + \Gamma_1 z^{-1}) = \frac{0.125(z^2 + 6z + 1)}{z(z^2 - 2z + 1)}$$

Order: 3

Poles: 0, 1, and 1

Zeros: $-3 \pm \sqrt{8}$

Calculation of $H(z)$ Given $G(s)$

ZOH sampling is a linear operation, so a transfer function $G(s)$ may be split into smaller parts $G_1(s) + G_2(s) + \dots$ that are sampled separately

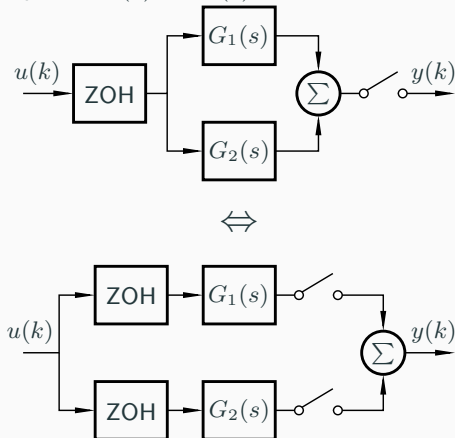

This does not hold for series decomposition, i.e.,
 $\text{ZOH}(G_1(s)G_2(s)) \neq \text{ZOH}(G_1(s))\text{ZOH}(G_2(s))$

Transformation of Poles via ZOH Sampling: $z_i = e^{s_i h}$

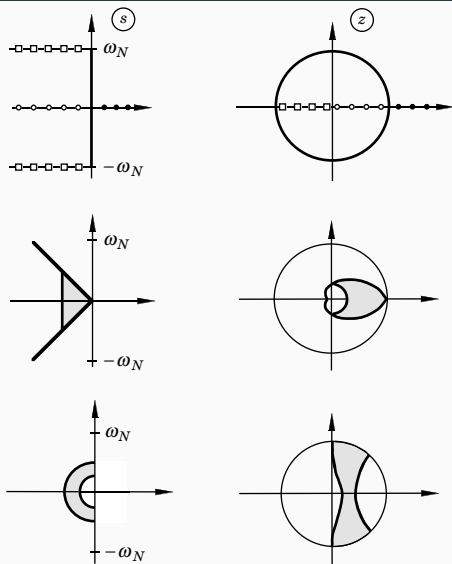

Note: The stability properties are preserved by ZOH sampling!

New Evidence of the Alias Problem

Several points in the s -plane are mapped into the same point in the z -plane. The map is not bijective

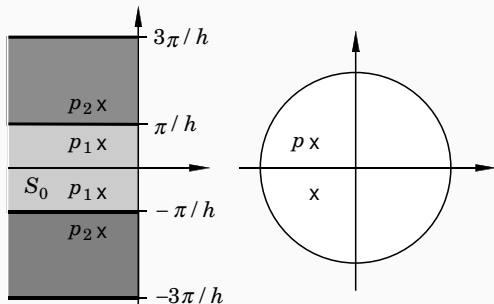

Transformation of Zeros via Sampling

- More complicated than for poles
- Extra zeros may appear in the sampled system
- There can be zeros outside the unit circle (non-minimum phase) even if the continuous system has all the zeros in the left half plane
- For short sampling periods

$$z_i \approx e^{s_i h}$$

ZOH Sampling of a Second Order System

Second order continuous-time system with complex poles:

$$G(s) = \frac{\omega_0^2}{s^2 + 2\zeta\omega_0 s + \omega_0^2}, \quad \zeta < 1$$

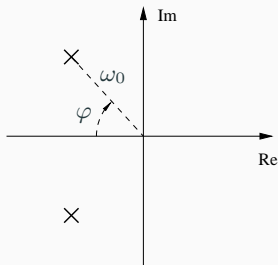

- Larger $\omega_0 \Rightarrow$ faster system response
- Smaller $\varphi \Rightarrow$ larger damping. Relative damping $\zeta = \cos \varphi$.
 - Common control design choice: $\zeta = \cos 45^\circ \approx 0.7$

Sampled Second Order System

The poles of the sampled system are given by

$$z^2 + a_1z + a_2 = 0$$

where

$$a_1 = -2e^{-\zeta\omega_0h} \cos\left(\sqrt{1-\zeta^2}\omega_0h\right)$$

$$a_2 = e^{-2\zeta\omega_0h}$$

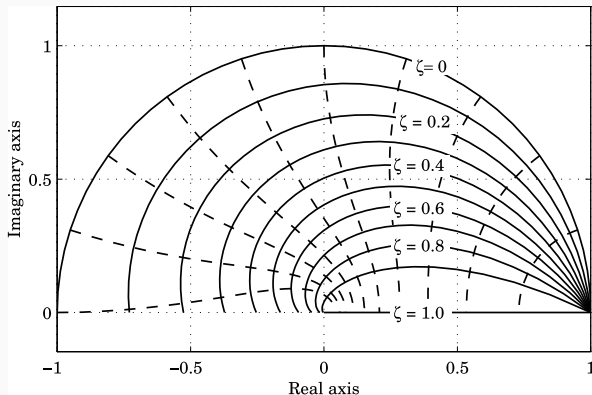

Sampled Second Order System

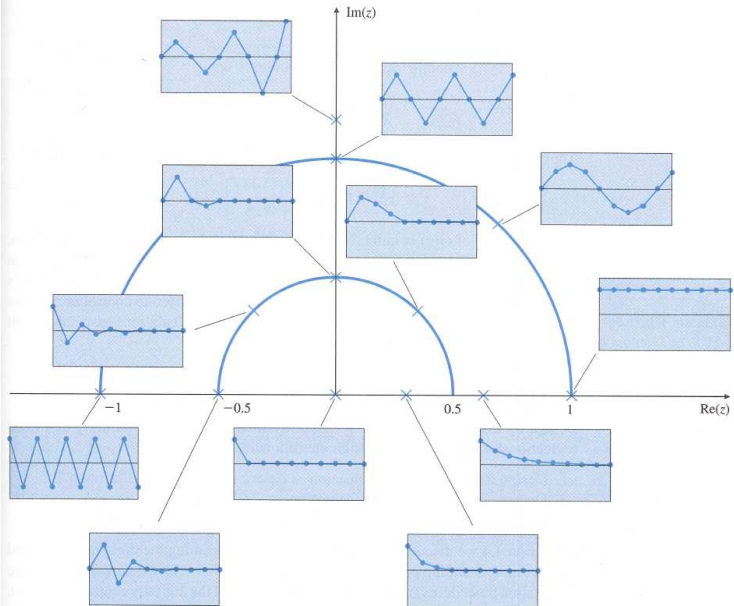

Examples in Matlab

```
>> % From state space system to pulse transfer function
>> A = [0 1; 0 0];
>> B = [0; 1];
>> C = [1 0];
>> D = 0;
>> contsys = ss(A,B,C,D);
>> h = 1;
>> discsys = c2d(contsys,h);
>> tf(discsys)      % pulse transfer function
>> zpk(discsys)     % factored pulse transfer function
>> % Bode and Nyquist diagrams
>> s = tf('s'); G = 1/(s^2+1.4*s+1);
>> H = c2d(G,1);
>> bode(G,H)
>> nyquist(G,H)
>> % Sampling of a second-order transfer function
>> G = 1/(s^2+s+1);
>> h = 0.1;
>> H = c2d(G,h)
>> pzmap(H)
```